



Electrically powered

Radio remotely controlled



Extreme low height

Only 1 person required for operation

Loads and unloads the nosewheel automatically with one tap on the remote

Park your aircraft using the last corner of your hangar and save space

Flexible use for all aircraft up to 85 tonnes

German Engineering with Passion.



TWIN SERIES

3900 / 6500 / 7500 / WIDE 14



The safest and most effective way of moving aircraft towbarless. Electrify your Ground Handling.





Mototok TWIN.
The difference to any other tug system:
Flexibility, safety, cost savings –
at the highest innovative level.



Mototok – Introduction of the best aircraft tug worldwide	4
Take a look inside	6
Turning on the spot with no wingtip movement: The Mototok Principle	7
The top advantages of using a Mototok tug	8
A comparison between towing principles	10
Mototok for Hangar Operations	14
Which Mototok model for which aircraft type?	16
Ground Handling goes digital	18
AGV – Automatic, camera-guided steering control	20
German art of engineering	22
Our customers	24
Technical Data	26
Dimensions	27



There are many different features of the Mototok compared to any other tug in the industry.

A big idea in a small format. Name: Mototok. Distinguishing features: Fully electric drive. Revolutionary in its simplicity. Extremely compact. Uniquely flexible. And very high performance.

With the remote control feature of the Mototok, the operator is able to move anywhere around the aircraft to see every vantage point. The operators eyes never leave the aircraft while it is in movement.



Lineage[®] 1000E
BY EMBRAER

10000 KG FLAT

Ototok
Maintenance



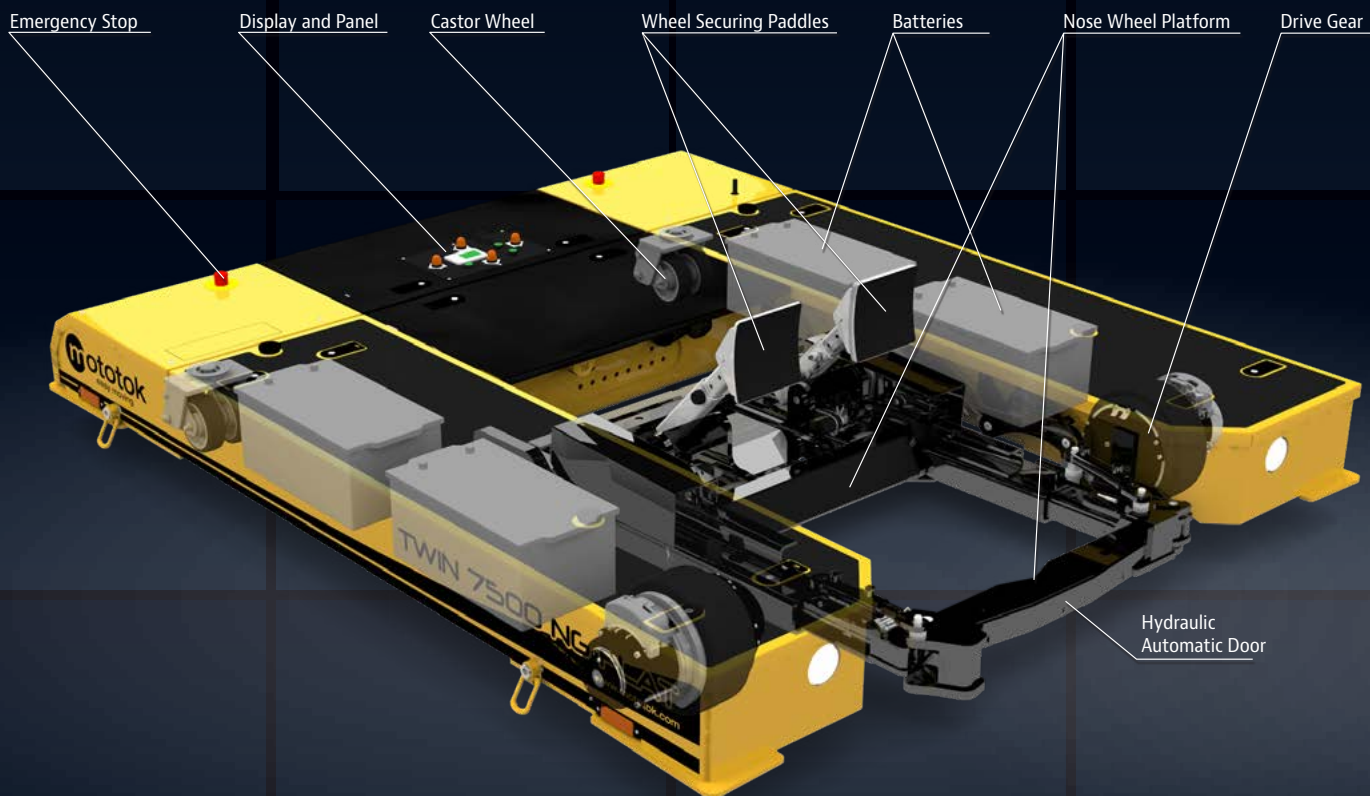

Take a look inside.

Extremely powerful electric motors – driven by high-performance, maintenance-free batteries with high cycling capability, regulated and controlled by two micro-processors provide enormous driving forces. Extremely high initial torque ensures smooth acceleration, particularly at the start. Storage capacity is sufficient for lots of operations.

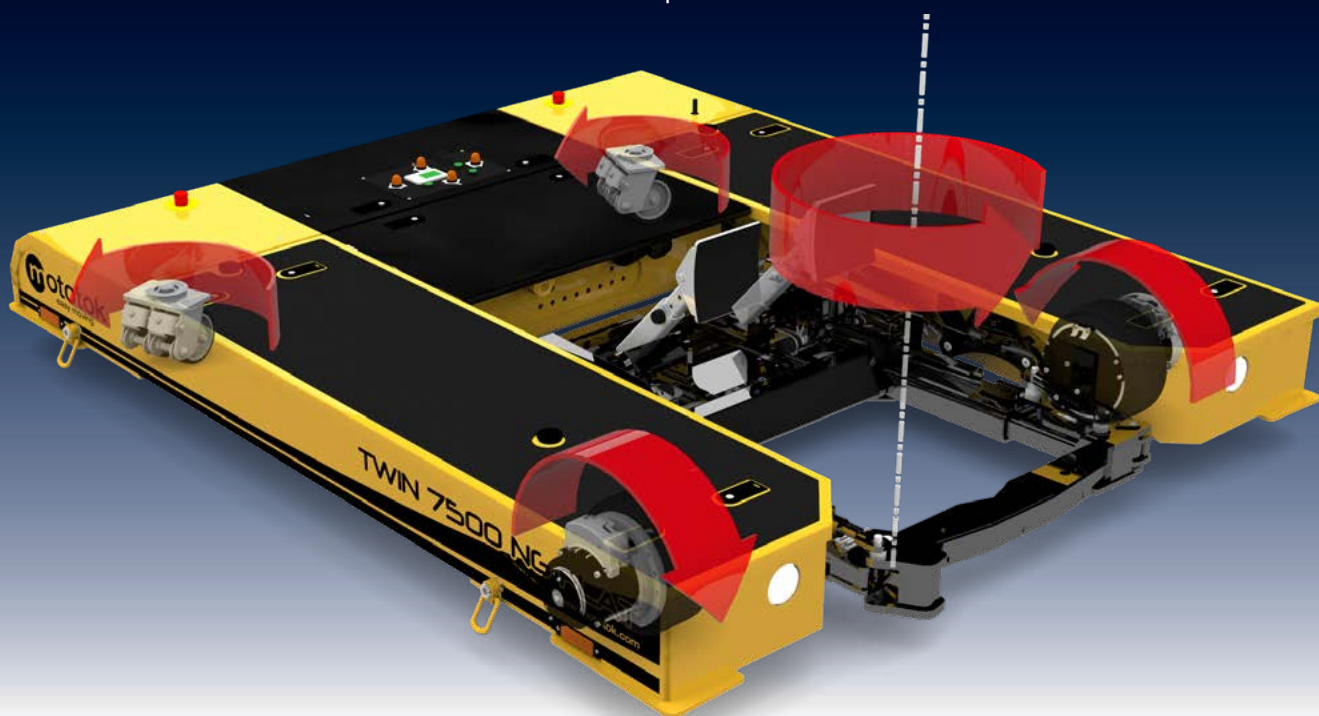



Turning on the spot with no wingtip movement: The Mototok principle.

Mototok is intelligent. The steering of a Mototok is performed through different rotating speed of both processor-controlled wheel-hub motors. A perfect turn on the spot is naturally no problem: one motor rotates forwards, the other backwards. Both motors recognise rotational resistance and carry out a precise turning manoeuvre. The aircraft remains almost immovable from its location during the turn. Therefore, accidents through collisions are practically out of the question. Additionally, transverse forces are not inflicted upon the nosewheel and landing gear hence no damage will be caused to the bearings and other landing gear related components. According to the relative rotation speed of both driving wheels every route can be performed.

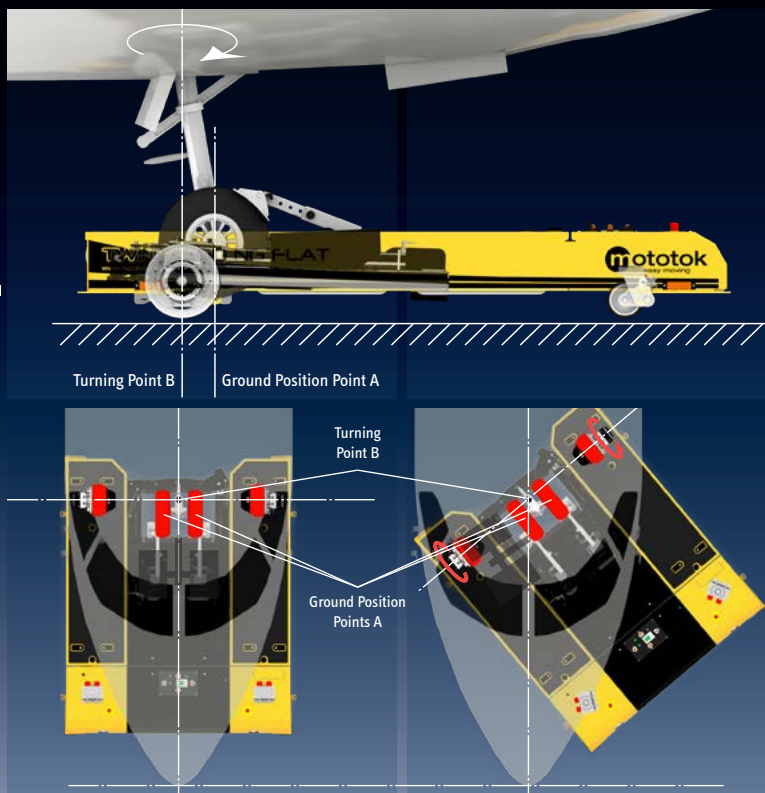

The top advantages of using a Mototok tug.



Towing with a conventional Tractor:
At least 4 Persons needed

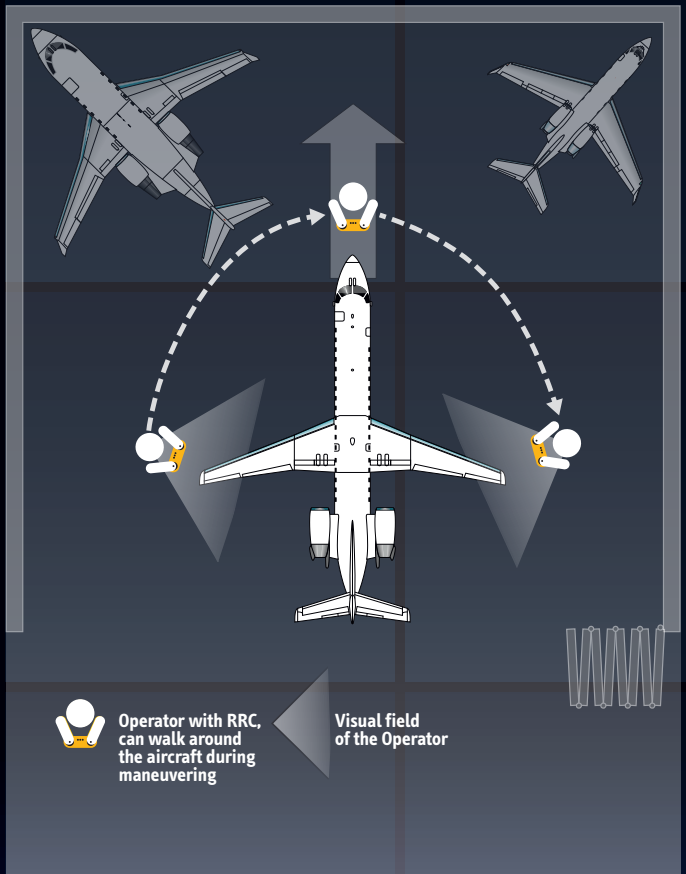

Circumferential view – only one person with a radio remote control (RRC) needed for moving the aircraft

→ Industrial radio remote control. The operator is able to walk around the aircraft during maneuvering – he is essentially his own „wing-walker“

→ „Hands free“ connection to the nose gear. Engaging and disengaging is done automatically in seconds by a tap on the remote.

→ No exit or entry path to consider for engaging and disengaging of the nose gear. Park your aircraft where you want – closely against a wall or in the hangar's corner

→ Low to no maintenance costs. No bulky diesel engine – clean electric drive.

→ Uniquely designed and microprocessor controlled.

Cost effective.

- Low personnel costs by means of wireless transmission control – the operator is essentially a “wing walker” himself
- Increases the number of aircrafts in your Hangar
- No driving licence required
- Extremely low maintenance costs, no maintenance plan necessary

Flexible.

- Maneuver a wide range of aircraft with the same Mototok-model – ONE MACHINE for all corporate aircraft single or double nose wheel including helicopters
- Connect the aircraft from the front or the rear
- Hydraulic nose wheel adjustment * – for different nose wheel diameters

Safe.

- Hydraulic fixation of the nose wheel
- Fully programmable speeds, braking curves, initial torques and over steering protection *
- Gentle treatment of the landing gear with a built in hydro-pneumatic system
- 100 % circumferential visual control around the aircraft. No knocks. No collisions. Optimum use of limited space!

* Available on some Mototok models only

Easy-to-use.

Docking takes a matter of seconds from the rear or front of the nose wheel. Simply drive the Mototok up to the nose wheel. The wheel is then hydraulically fixed firmly in position and raised – ready for take off! All this with no awkward strap, no inconvenient winch. No bolts or tools are required.

→ Radio remote controlled operating under an industrial frequency code approved for airports.

→ Automatic connection to the aircraft’s nose wheel with one click.

→ No straps, no winch, no tools required.



Automatic One-Click Loading.

As simple as pressing a button:

1. The door closes hydraulically
2. The platform lifts up
3. The securing paddles clamp the nosewheel gently

Why is Mototok the best tug system in the market?

A comparison between towing principles.

Conventional tow tractor with a tow bar

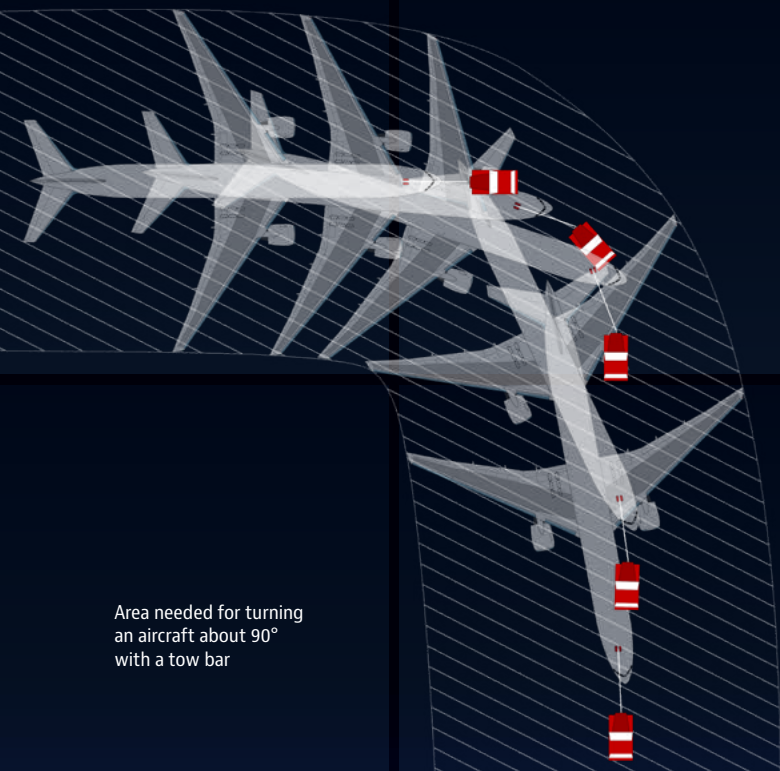

Maneuvering with a towbar means “steering by moving”. Turning the nose gear and moving the aircraft are two inseparable motions when using a tow bar. Turning the nose wheel is only possible when the aircraft is moved backwards or forwards. The aircraft has to be moved several meters for the nose gear to turn and move the aircraft into another direction. This in turn increases the space required for manoeuvres.

- ⊖ **Many different tow bars** have to be stored for different types of aircraft.
- ⊖ **High risk of accidents and damage** of the aircraft.
- ⊖ At least **one second person necessary as a wing-walker** due to the minimized view of the operator.
- ⊖ **High maintenance level** due to combustion engine.

Other towbarless tugs

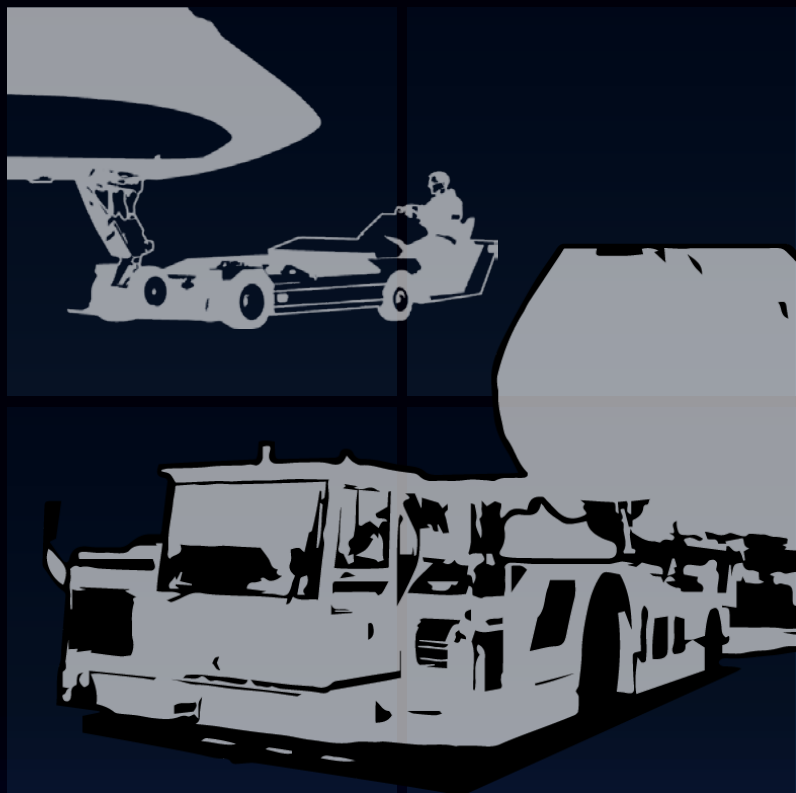

This principle means also “steering by moving”. The space requirement is approximately the same as with using a tow bar.

- ⊖ **Winches and straps** for fixation often needed.
- ⊖ At least **one second person necessary as a wing-walker** due to the minimized view of the operator.
- ⊖ The vehicles have **large dimensions** and **require a lot of parking space**.

Best Choice!

Tugs with a rotary table

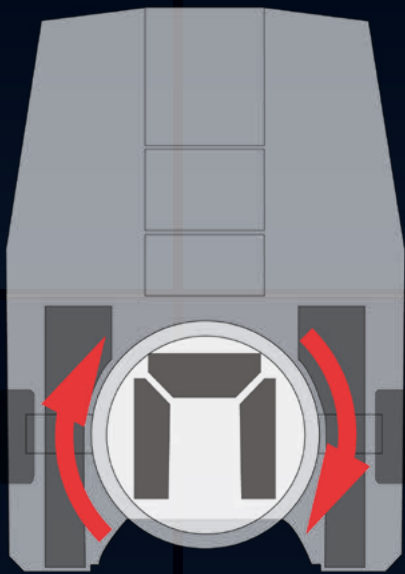

The nose landing gear is clamped on a rotating turntable to prevent damage to the nose wheel if the maximum turning angle of the nose wheel is reached. The aircraft tractor can continue to turn, but the turntable remains stationary.

- Can load the aircraft **only from the side** of the aircraft.
- The **Oversteering Protection System** only **works reliably** when **pulling** the aircraft. When pushing, the turntable behaves in a similar way to the castor on a shopping trolley due to the nose wheel's overrun: the wheel turns. This can only be prevented by manually fixing the turntable by the operator. **But this deactivates the oversteering protection function.**
- **No automatic fixation of the nose gear:** there is no possibility of bringing **hydraulic** or **electrical lines** into the **rotating platform** without risking a timely defect.
- **Safety issue:** Due to the large and unfavourably placed drive wheels, there is a **danger of crushing** the operators feet during manoeuvring

Moving an aircraft the innovative way – with Mototok!

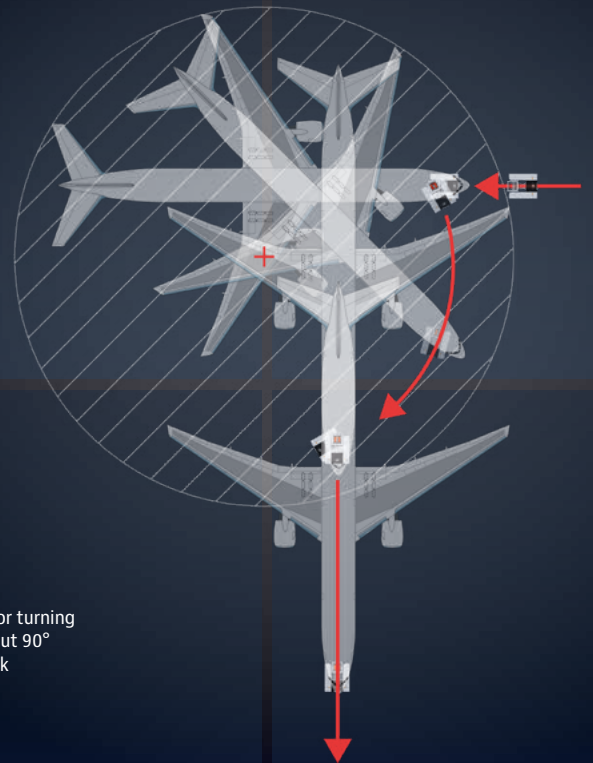

Area needed for turning an aircraft about 90° with a Mototok

Manoeuvring with Mototok is the easiest and safest by far. With Mototok, both turning the nose gear and moving the aircraft are two completely different movements. The fuselage and wingtips remain in position whilst turning the nose gear. The result is a minimum requirement of space. This example shows that turning an aircraft by 90° reduces manoeuvring space to a circle.

- + **Best overall sight** thanks to remote controlled maneuverings.
- + **No winches, no straps:** Convenient and quick automatic nose gear loading.
- + **Low maintenance** thanks to full electric drive.
- + **Lowest space requirement** when pushing or pulling the aircraft.
- + **Safe** thanks to **oversteering protection** on many models.



"Our Mototok is the second best piece of equipment in the hangar (the airplane is first)!"

"The ease of operation and the ability for one person to safely maneuver our plane in and out of our hangar because of the industrial remote control wing walker feature is unbeatable. This is a quality machine, very reliable."

Steve Nelson, Aviation Manager & Chief Pilot,
TLS Aviation LLC



Top: The view outside a standard tug – the operator needs at least two additional wing walkers.

Middle: Working with conventional tugs

Bottom: Using towbars or other towbarless systems means cumbersome handling

Moving an aircraft the innovative way – with Mototok: Circumferential view around the aircraft, easy and convenient handling



**Mototok for Hangar Operations:
Only Mototok generates up to
60% more space in your hangar.**



Mototok excels in tight situations: Park your aircraft safely, easily and effectively where you want: In the hangars corner, directly towards the hangars wall or near by other aircraft in the hangar. Save space in the process – depending on your hangar situation up to 40%.

Operating with normal tugs with or without a towbar is intricate. Turning the nose wheel whilst maneuvering without moving the aircraft is impossible. Additionally the operator has to consider the exit path of the tug. Thus, parking the aircraft with old technology is unprofitable. You are not able to use your hangars full capacity.

The low height, the compact design and the radio remote control of mototok tugs gives you the fully control of the hangars space. It saves costs through optimized use of limited space.

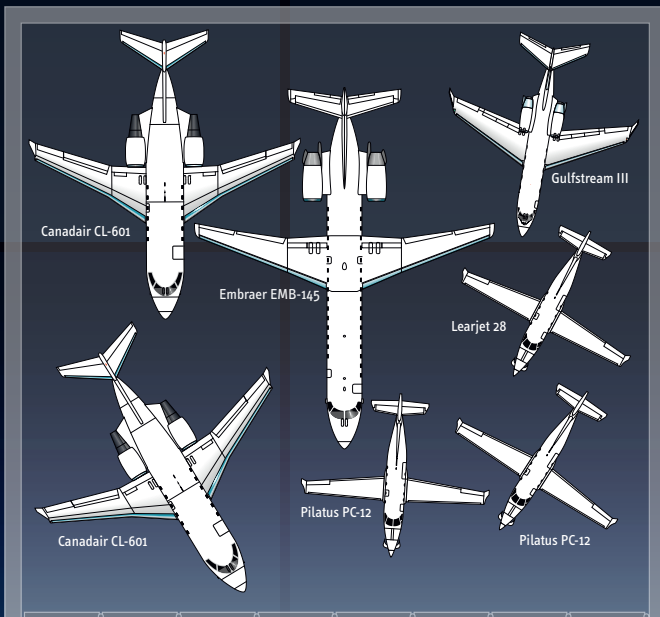
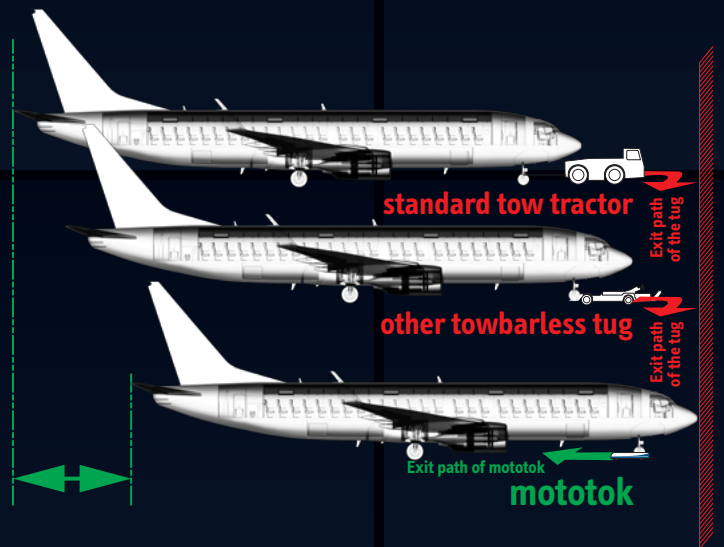

Typically situation in a hangar – managed with a conventional tow tractor. The biggest disadvantages are:

- ⊖ All aircraft faces to the hangars gate because you have to consider the exit path of the tow tractor. Parking directly in a hangars corner is impossible.
- ⊖ The distance between the aircraft has to be acceptably big.

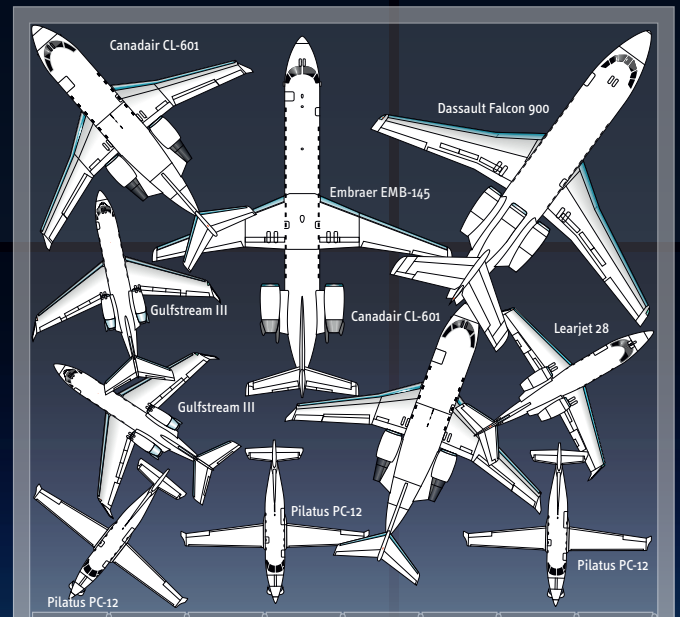

Same hangar with electric wireless remote controlled Mototok aircraft tug:

- ⊕ Park your aircraft directly towards a wall or in the hangars corner. You don't have to consider the exit path of mototok.
- ⊕ „Stack“ aircraft – park your aircraft with extreme minimal distance. Maneuvering in extreme narrow situations is no problem.

You are not able to use your hangars full capacity!

Increase the capacity of your hangar up to 60% by optimizing parking space!



**TOWING
CAPACITY** UP TO
39/50/75 t
(85,980 / 110,230 /
165,300 lbs)

**HANGAR
OPTIMIZATION**



Mototok TWIN Series The world's most compact tug suitable for all aircraft.

- Fully automatic nose gear engaging function
- Applicable for single or double nose wheel
- Hydraulic adjustment of the mouth opening depth for wheels with small diameter
- Speed up to 1.5 m/s
- 3 different models available for aircraft up to 39, 50 or 75 t, also as FLAT* models with extreme low height

(* Not model TWIN 3900)

Which aircraft suits which Mototok TWIN? (Extract)

	Mototok TWIN 3900	Mototok TWIN 6500	Mototok TWIN 7500
Aircraft like			
Bombardier Challenger			
Embarer Legacy 500 / 600			
Embraer ERJ 135 / 145 / 175			
Lear Jet			
Cessna Citation Sovereign 680			
Beechcraft King Air			
Dassault Falcon			
Hawker			
Pilatus			
Gulfstream 650			
Embraer ERJ 175 E2			
Bombardier Global Express			
AVRO RJ 70/85/100			
ATR			
Embraer 190 / 195 / Lineage 1000			
Boeing 737 BBJ			
Helicopter like			
Sikorsky			
Boeing			
Eurocopter			
Bell			
AgustaWestland			
NH 90			
Military Machines like			
Eurofighter			
Tornado			
F16			
F18			
Saab Gripen			
Dassault Rafale			
Grumman Hawkeye			



**Ground Handling goes digital.
Our new soft- and
hardware features.**



This central processing unit makes your Mototok even more efficient. With this CPU, your Mototok has an interface for checking and setting various options, like

- Towing and braking forces
- Oversteering protection and counter steering
- Voice announcements
- Unit diagnostics
- Log files
- User access

The CPU can be linked with any mobile device (smartphone, tablet or laptop) directly on site or – with the help of the Mototok Cloud – also via the World Wide Web. Remote maintenance can be easily performed using this interface: both your and our technicians can change settings, check the device or provide assistance with any necessary maintenance work – regardless of the location of the Mototok.

With the help of an RFID card reader and corresponding personalized key cards, an operator can log on and operate, set or maintain the device depending on his authorization level.

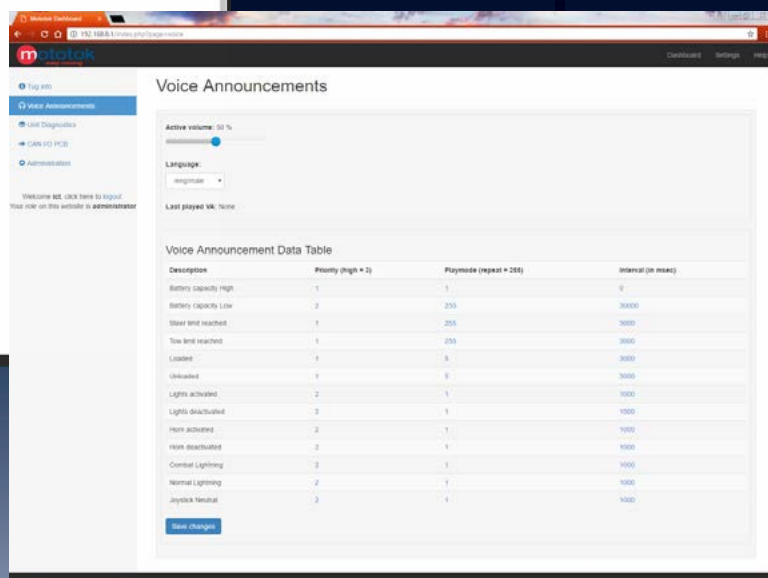
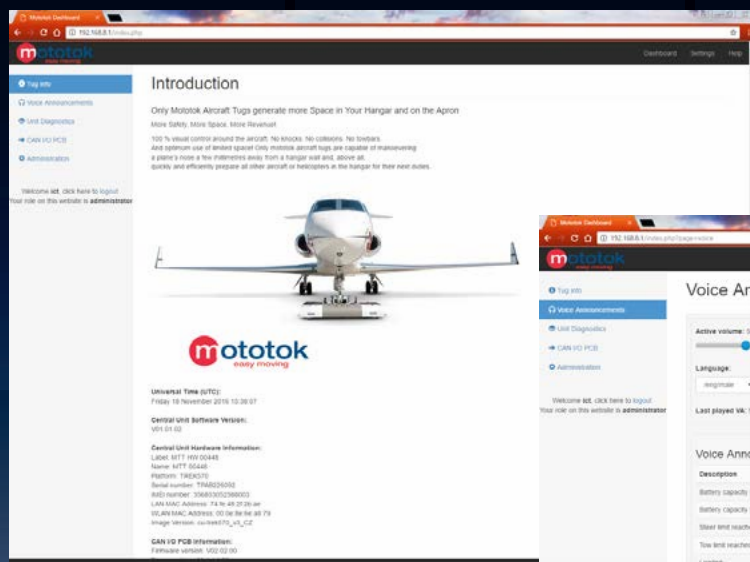
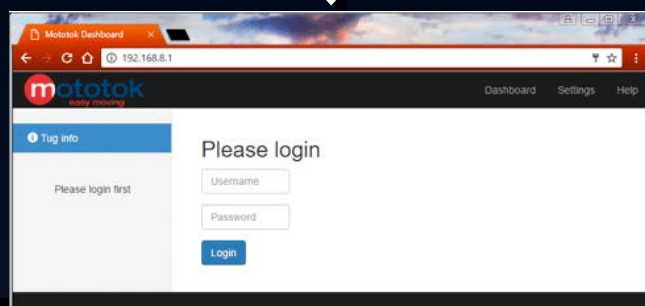
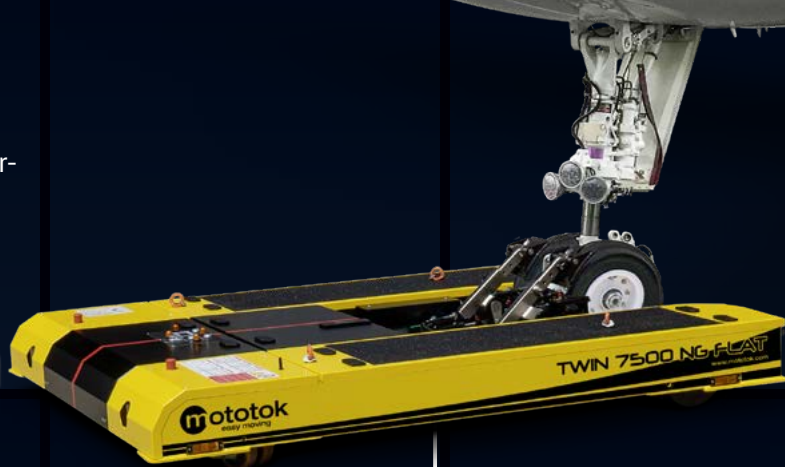



Autonomous Driving.

Moving an aircraft between four walls and other obstacles – with a Mototok an easy and safe way. But you can increase the safety once more by using our solutions for autonomous driving.



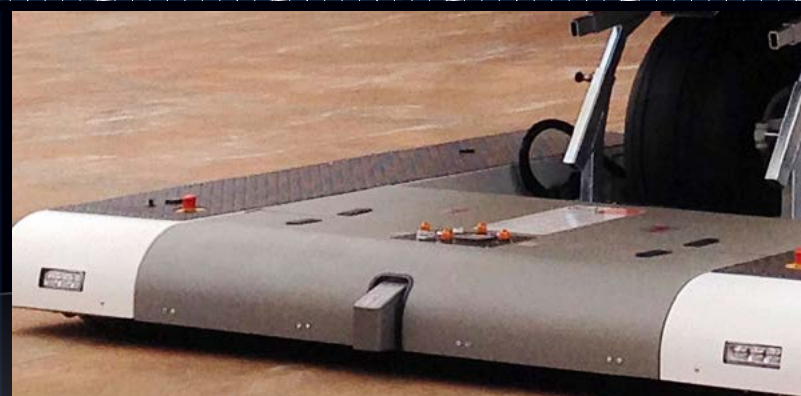
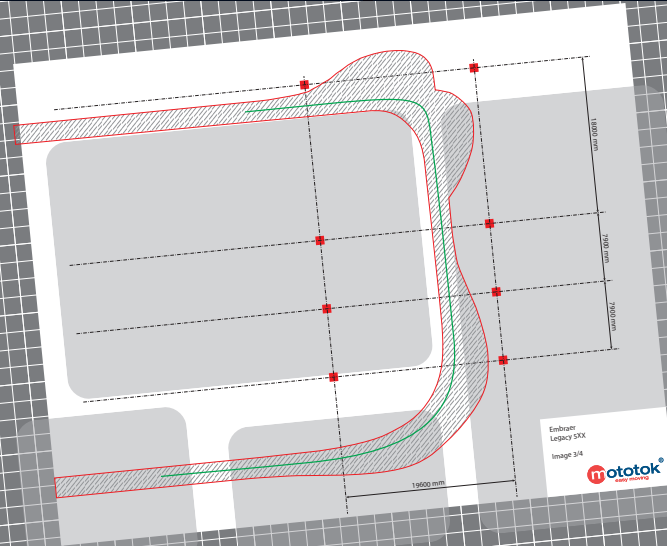
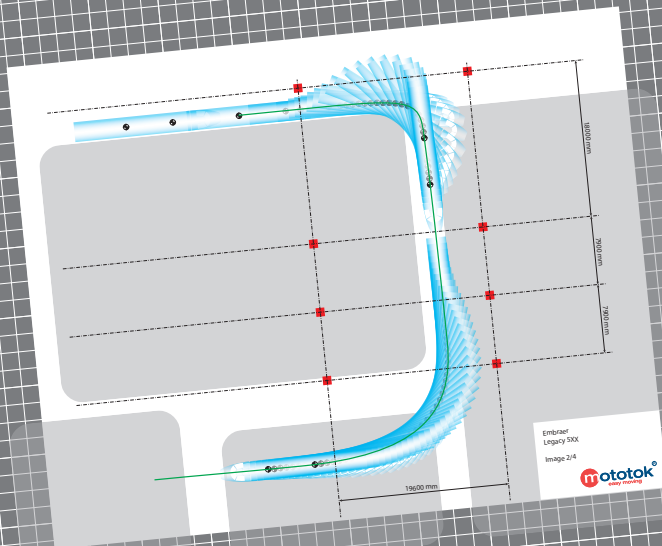

Mototok can be controlled in different ways

- Optically by a line with barcodes for automatically brake down or speed up, stop or change the course in case of junctions
- Inductive using induction loops
- GPS

The advantages of using autonomous driving:

- No accidents
- No stress
- No wrong drives
- High reliability
- More precise driving
- Gentle transport for vehicle and load
- exact route planning
- Optimized routing
- Lower personnel costs.

On production lines during aircraft manufacture, Mototok is a versatile tool that can be used with great flexibility. During assembly, Mototok automatically moves the aircraft fuselage to the individual assembly points. In very space-restricted production environments, two synchronized Mototoks may also be used.

Of course, we are at your disposal for advice and assistance in planning the optimal use in your hangar or production facility.

These and other well-known aviation companies use our automatic tracking technology in their production facilities:





**Working with fire and steel:
German art of engineering.**



Our innovative built to last aircraft tractors are best equipped for daily heavy use as they consist of high-grade material, hand-picked components according to the finest engineering designs. Our products are capable of withstanding the toughest conditions when exposed to wind and salt water. Thanks to a selection of the finest materials, only limited maintenance is necessary.

Our production process corresponds and applies to all necessary demands and conditions required in the engineering industry.

2006/42/EC	Machinery Directive (MD)
2014/35/EU	Low Voltage Directive (LVD)
2014/30/EU	Electromagnetic Compatibility Directive (EMC)
2014/53/EU	Radio Equipment Directive (RED)
EN 1915-1	Aircraft ground support equipment – General requirements – Part 1: Basic safety requirements
EN 1915-2	Aircraft ground support equipment – General requirements – Part 2: Stability and strength requirements, calculation and test methods
EN 12312-7	Aircraft ground support equipment – Part 7: Aircraft movement equipment
EN ISO 12100	Safety of machinery – General principles for design – Riskassessment and risk reduction
EN 1175-1	Safety of industrial trucks – Electrical requirements – Part 1: General requirements for battery powered trucks
EN ISO 4413	Hydraulic fluid power – General rules and safety requirements for systems and their components
EN ISO 13849-1	Safety of machinery – Safety-related parts of control systems – Part 1: General principles for design
EN 60204-1	Safety of machinery – Electrical equipment of machines – Part 1: General requirements

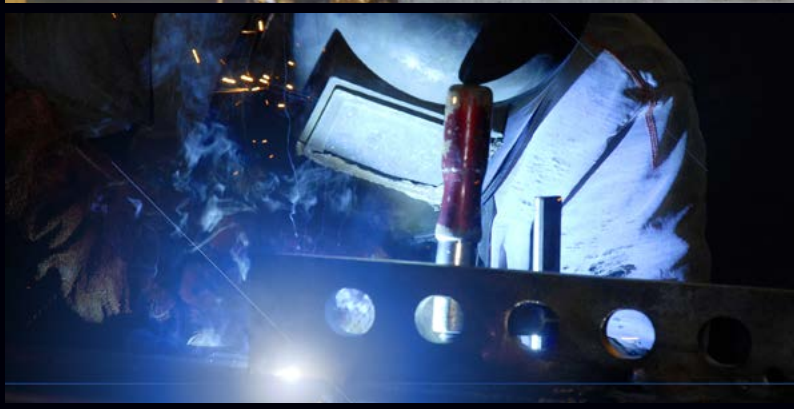

Satisfaction guaranteed – our customers

(extract)

Airports

Bern	Switzerland	Airport	Several Aircraft
Birmingham	USA	Shuttlesworth International Airport	Several Aircraft
Burbank	USA	Bob Hope Airport	Several Aircraft
Cannes	France	Mandelieu Airport	Several Aircraft and Helicopter
Chicago	USA	Chicago Executive Airport	Several Aircraft
Dallas	USA	Dallas Love Field	Several Aircraft
Denison	USA	North Texas Regional Airport	Several Aircraft
Dresden	Germany	Airport	General Aviation
Dublin	Ireland	International Airport	Several Aircraft
Glasgow	UK	International Airport	Several Aircraft
Indianapolis	USA	International Airport	Several Aircraft
Kuala Lumpur	Malaysia	Sultan Abdul Aziz Shah International Airport	Several Aircraft
London	UK	Luton Airport	Several Aircraft
Lugano	Switzerland	Airport	Several Aircraft Helicopter Agusta and others
Lyon	France	Saint Exupery Airport	Several Aircraft and Helicopter
Malaga	Spain	Airport Costa del Sol	Several Aircraft and Helicopter
McKinney	USA	National Airport	Several Aircraft
Minneapolis	USA	Saint Paul International Airport	Several Aircraft
Moskow	Russia	Domodedovo Airport	Several Aircraft and Helicopter
Orlando	USA	Sanford International Airport	Several Aircraft
Panama	Panama	Albrook „Marcos A. Gelabert“ International Airport	Several Aircraft
Philadelphia	USA	International Airport	Several Aircraft
Provo	USA	Municipal Airport	Several Aircraft
Santiago de Chile	Chile	Arturo Merino Benítez International Airport	Several Aircraft
Seattle	USA	Tacoma International Airport	Several Aircraft
Seattle	USA	King County International Airport	Several Aircraft
Sion	Switzerland	International Airport	Several Aircraft
Truckee	USA	Tahoe Airport	Several Aircraft
Tulsa	USA	International Airport	Several Aircraft
Waukegan	USA	Regional Airport	Several Aircraft
Zürich	Switzerland	International Airport	Several Aircraft and Helicopter

FBO / MRO

ACC Columbia, Hannover & Cologne	Germany	Global & others
ACI Jet Center	USA	Several Aircraft
AERO Dienst, Nuremberg	Germany	FBO
Air Service Basel	Switzerland	G5, Global Express, Boeing 737
AirMec	Angola	MRO / Military Aircraft
Alpark SA	Switzerland	Several Aircraft
Cannes	France	Several Aircraft and Helicopter
Centeravia		Several Aircraft
DUNCAN Aviation	USA	Several Aircraft
Flying Group, Antwerpen	Belgium	Several Aircraft
Glasgow	UK	Several Aircraft
Hawker Pacific Asia Pte Ltd	Singapore	Several Aircraft
Jet Alliance Vienna	Austria	Several Aircraft
Jet Legacy Center, Tulsa	USA	Several Aircraft
JetAviation, Geneva	Switzerland	Several Aircraft
London	UK	Several Aircraft
Lyon	France	Several Aircraft and Helicopter
Panaviatic Ltd	Estonia	Several Aircraft
Perth	Australia	FBO
Santiago de Chile	Chile	Several Aircraft
Sapura Aero	Malaysia	Several Aircraft
Silk Way Airlines, Baku	Azerbaijan	Several Aircraft
Starport Aviation	USA	Several Aircraft
Synergy Flight Center	USA	Several Aircraft
Tarkim Air	Turkey	General Aviation
XJEt	UK	Several Aircraft
FAI Nürnberg	Germany	Several Aircraft
Executiv Jet Service	Switzerland	Several Aircraft
Alpin Sky Jets	Switzerland	Several Aircraft
Aeroground Berlind GmbH	Germany	Several Aircraft
DC Aviation GmbH	Germany	Several Aircraft
Dedeman	Rumänien	Several Aircraft
Execujet New Zealand	Neuseeland	Several Aircraft
Falcon Aviation Services	UAE	Several Aircraft
JetEx	UAE	Several Aircraft
Flying Service	Belgien	Several Aircraft
GCH Aviation	Neuseeland	Several Aircraft
Hawker Pacific Asia Pte Ltd	Australien	Several Aircraft
Jet Flight Air Services	Neuseeland	Several Aircraft
Japat AG	Switzerland	Several Aircraft
Luxembourg Air Rescue	Luxembourg	Several Aircraft
Volkswagen AG	Germany	Several Aircraft
ADAC Luftrettung	Germany	Skidded Helicopter

AIRBUS

Aero-Dienst
Your Jet - Our Job - Since 1958

airservicebasel

BOEING

MENZIES AVIATION

Alaska Airlines

BRITISH AIRWAYS

Gulfstream

Aircraft Manufacturers

Airbus S.A.S., Hamburg	Germany	Spacer
BOEING	USA	Plant in Philadelphia AGV
BOMBARDIER, Montreal	Canada	Global Express Delivery Center
Dassault Aviation	France	Twin
EMBRAER S.A.S. José dos Campos	Brasil	Embraer 195, 190, 175, 170, KC 390
Pilatus Aircraft Ltd	Switzerland	PC 12 Maintenance & Delivery
Rosvertol PLC	Russia	Helicopter Production MI-series
Sikorsky	USA	
Turkish Aerospace Industries, Inc. (TAI)	Turkey	F 16 Fighter Maintenance Facility, Tiger Maintenance Facility
Xi'an Aircraft Company	China	Y 20

Corporations

Abbvie	USA	
ABP Food Group	Ireland	
Access Aviation	UK	
ACM	Chile	
ACSI Corporation	USA	
Alpine Sky Jets	Switzerland	
American Colors International	USA	
Anglo American	South Africa	Agusta AW139, G5
C & P Aviation	USA	
Caribbean Investor Group	USA	
CNH Industrial	The Netherlands	
Columbia Pacific Management	USA	
Comcast	USA	Several Aircraft
Cook Canyon Ranch	USA	
Disney	USA	
Gazprom Avia, Moscow	Russia	Falcon jets
Harbert Aviation	USA	
Home Depot	USA	Several Aircraft
Indianapolis Colts	USA	
L-3	USA	Several Aircraft
Novartis AG (JAPAT AG), Basel	Switzerland	Global Express, EC 135
OAQ Gazprom	Russia	Several Helicopter & Aircraft
Regions Financial Group	USA	
State Farm	USA	Several Aircraft
Taxxas	USA	
The Boler Company	USA	
The CocaCola Company	USA	Several Aircraft
The Duchossois Group	USA	
TLS Aviation	USA	

Government

Sultanat of Oman	Oman	Eurocopter Super Puma Fleet
------------------	------	-----------------------------

Military

Brazil Navy	Brasilien	Onboard Helicopter
CASSIDIAN Manching (EADS)	Germany	Tornado & Eurofighter
China Military	China	All kind of Aircraft, Helicopters
Columbian Air Force	Columbia	
Danish Army	Denmark	Challenger, Agusta EH 101, F 16
French Navy / Air Force	France	Rafale Fighter, SuperPuma, NH 90, EC 155, Panther
Israel Airforce	Israel	Alenia Aermacchi M-346 Master
Pakistan Military	Pakistan	HELIMO for Helicopters with skids
Peru Navy	Peru	Helicopter on the BAP Pisco
South Korea Costguard	South Korea	Onboard Helicopter
Thailand Army	Thailand	
U.S. Army National Guard	USA	M 528
US Airforce (in England)	UK	F 15
Venezuela Military	Venezuela	Helicopters with skids & with wheels

Special Forces

Federal Police	Germany	Helicopter Super Puma, EC 155
Guardia di Finanza Rome	Italy	ATR

Airlines

Aegean Airlines	Greece	
Air Nostrum, Líneas Aéreas del Mediterráneo S.A	Spain	
Alaska Airways, Seattle	USA	BOEING 737 Family
British Airways	UK	AIRBUS 320 Series
HOP!	Frankreich	
Iberia, Líneas Aéreas de España S.A.	Spain	Spacer for BOEING and Airbus
Thomson/TUI, Luton	UK	BOEING 737 Family

Pushback

Allegiant Air	USA	
ANA – All Nippon Airways	Japan	
British Airways	UK	28 Machines at Heathrow T5
Changsha Huangpi Airport	China	
DNATA	UAE	Demo
Figari-Sud Corse Airport	Frankreich	
FRAport	Deutschland	Demo
JetBlue	USA	Demo
Rovaniemi Airport	Finnland	Demo
TCR	UK	

BOMBARDIER
the evolution of mobility

 **DASSAULT**
AVIATION







 **EMBRAER**  **JET AVIATION**

 **DUNCAN**
AVIATION

 **IBERIA**

 **PILATUS**  **Thomson**

Technical Data

		TWIN-SERIES					
		3900 NG	6500 NG	6500 NG Flat	7500 NG	7500 NG Flat	WIDE 14
Use for		single & double nosewheel, wheeled helicopter	single & double nosewheel, wheeled helicopter	single & double nosewheel, wheeled helicopter	single & double nosewheel, wheeled helicopter	single & double nosewheel, wheeled helicopter	double nose wheel
							
Maximum towing capacity ¹⁾		39 t 85980 lbs	50 t 110231 lbs	50 t 110231 lbs	75 t 165347 lbs	75 t 165347 lbs	85 t 187393 lbs
Maximum nosewheel weight capacity		4,5 t 9920 lbs	6 t 13228 lbs	6 t 13228 lbs	7,5 t 16535 lbs	7,5 t 16535 lbs	12 t 26456 lbs
Dimensions (without antenna, grips on the surface)	width	2136 mm 84.09 inch	2136 mm 84.09 inch	2136 mm 84.09 inch	2136 mm 84.09 inch	2136 mm 84.09 inch	2956 mm 116.38 inch
	length	2596 mm 102.20 inch	2596 mm 102.20 inch	2596 mm 102.20 inch	2596 mm 102.20 inch	2596 mm 102.20 inch	2596 mm 102.20 inch
	height	350 mm 13.78 inch	350 mm 13.78 inch	320 mm 12.60 inch	350 mm 13.78 inch	325 mm 12.80 inch	316 mm 12.44 inch
Ground clearance		110 mm 4.33 inch	110 mm 4.33 inch	85 mm 3.35 inch	110 mm 4.33 inch	85 mm 3.35 inch	95 mm 3.74 inch
Max width of the Nosewheel		665 mm 26.2 inch	665 mm 26.2 inch	665 mm 26.2 inch	665 mm 26.2 inch	665 mm 26.2 inch	1425 mm 56.1 inch
Nosewheel diameter	min.	250 mm 9.84 inch	250 mm 9.84 inch	250 mm 9.84 inch	250 mm 9.84 inch	250 mm 9.84 inch	180 mm 7.09 inch
	max.	700 mm 27.56 inch	700 mm 27.56 inch	700 mm 27.56 inch	700 mm 27.56 inch	700 mm 27.56 inch	670 mm 26.38 inch
Unladen weight		1700 kg 3750 lbs	1800 kg 3970 lbs	1800 kg 3970 lbs	2100 kg 4630 lbs	2100 kg 4630 lbs	3500 kg 7716 lbs
Time to load/fix aircraft (approx.)		10 sec	10 sec	10 sec	10 sec	10 sec	15 sec
Speed		5.4 km/h 1.5 m/s 3.36 mph	5.4 km/h 1.5 m/s 3.36 mph	5.22 km/h 1.45 m/s 3.25 mph	3.78 km/h 1.05 m/s 2.35 mph	3.78 km/h 1.05 m/s 2.35 mph	3.78 km/h 1.05 m/s 2.35 mph
Batteries (maintenance-free, deep cycle gel batteries)		4 x 220 Ah	4 x 220 Ah	4 x 220 Ah	4 x 220 Ah	4 x 220 Ah	4 x 220 Ah
Voltage		48 V	48 V	48 V	48 V	48 V	48 V
AC Microprocessor controlled electric motors		✓	✓	✓	✓	✓	✓
Range (depending on the workload)		3-4 days	3-4 days	3-4 days	3-4 days	3-4 days	3-4 days
Possible terrain		Concrete, stone	Concrete, stone	Concrete, stone	Concrete, stone	Concrete, stone	Concrete, stone
Tyres		Puncture-proof	Puncture-proof	Puncture-proof	Puncture-proof	Puncture-proof	Puncture-proof
Advanced radio remote control with safety features, waterproof, certification of conformity, worldwide safety approval including airports, TÜV certified 		✓	✓	✓	✓	✓	✓

Optional Equipment

Hydraulic nosewheel securing ²⁾	✓	✓	✓	✓	✓	✓
Hydraulic full hands free wheel opening doors	✓	✓	✓	✓	✓	✓
Ground power cable for ground power connection 13,4V / 25,6 V (short time up to 1300 A) ³⁾	available	available	available	available	available	available
Driving light (LED, 10,000 hour operating life, very high beam range)	✓	✓	✓	✓	✓	✓
Yellow flashlight	✓	✓	✓	✓	✓	✓
Safety beeper	✓	✓	✓	✓	✓	✓
Oversteering Protection	available	available	available	available	available	available
Software features (adjusting towing and braking forces, Oversteering protection and counter steering, Voice announcements, Unit diagnostics etc.)	available	available	available	available	available	available
Trailer coupling adaptor for multi-functional extensions	available	available	available	available	available	available
Military spiral cable connection (15 m) between aggregate and control unit	available	available	available	available	available	available
True Ackermann active 4-wheel-steering	available	available	available	available	available	available
Automatic controls by ground markings (AGV functionality)	available	available	available	available	available	available
Adaptations for special demands (i.e. military version / range of production)	available	available	available	available	available	available

Mistakes and technical alterations reserved

¹⁾ The stated towing capacity is valid for towing on normal ground conditions without any incline.

²⁾ This prevents the nosewheel from rising and slipping out of position. The securing device is hydraulically lowered onto the nosewheel and securely locked at the push of a button. Standard: mechanical securing system.

³⁾ In most aircraft, the generator voltage is 28.4 V. The 25.6 V on-board batteries are charged with this voltage. With the mototok ground power supply, the on-board voltage can be maintained and used to start the turbines. Functionality depends on the electronic of the aircraft.

Date 06.2019

Dimensions

Vertical stroke: 150 mm / 5.91"
 Sliding Table stroke: 300 mm / 11.81"
 Hydraulic Door stroke: 200 mm / 7.87"

Dimensions without hand grips, antenna, etc.
 Subject to change without prior notice

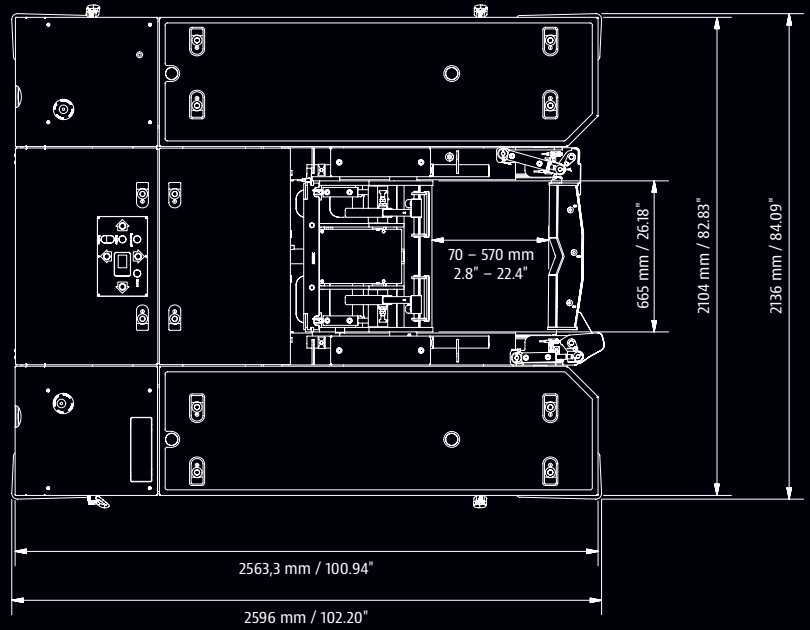

Standard Models 3900 NG / 6500 NG / 7500 NG

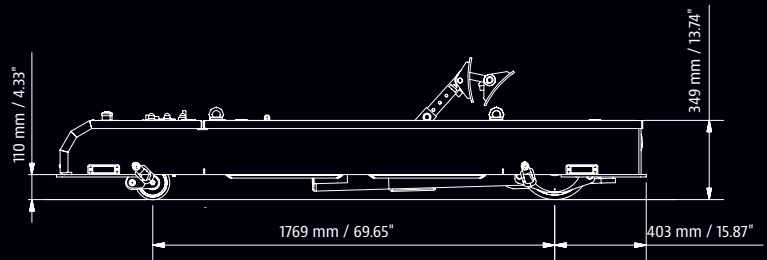
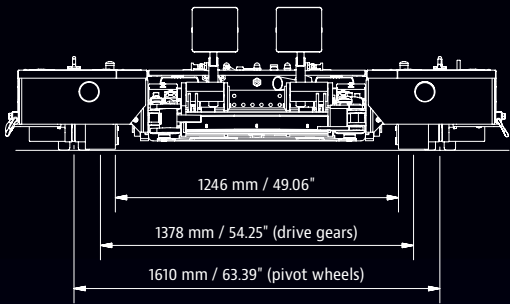

Flat Models

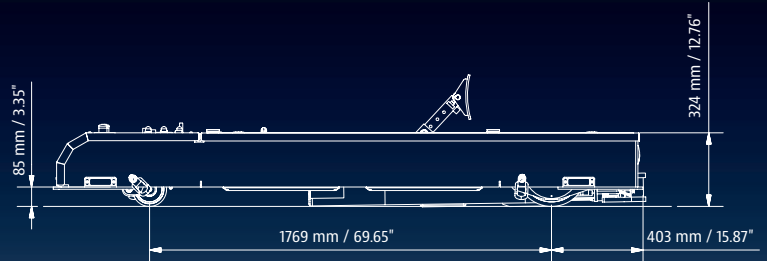
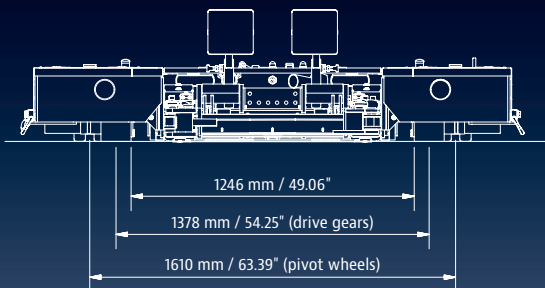

Mototok.

REVOLUTIONARY – FINDING INNOVATIVE SOLUTIONS OUT OF NECESSITY

Mototok was founded in 2003 by Kersten Eckert, avid aviator and creator of the Mototok, and his friend and partner Thilo Wiers-Keiser.

FUELLED BY PASSION

The invention of our aircraft tugs is a deeply personal story that began with Kersten Eckert's first solo flight at 18. His growing aggravation about a process efficient-minded Eckert considered far from ideal: Maneuvering the aircraft while on the ground. You know the rigmarole: Waiting for the machine being laboriously transported out of the hangar, depending on having two or even three people available to watch his wings and fuselage, needing a pilot to sit inside the aircraft ready to brake if needed ...Eckert became determined on finding not only a better, but the perfect way in terms of space, speed, and effort.

CREATING THE PERFECT PRODUCT

5 years of detail-oriented developing time later, the first Mototoks hit the market: Battery-powered industrial tugs providing an all-round view around the aircraft by high technology remote control, operated by a single person.

By now, there are Mototoks available for all aircrafts up to 250 tons. They are in use by international FBOs, MROs, aircraft manufacturers, special forces, airports, airlines, navy, military, industrial companies, businessmen and individuals with their own fleet.

Learn more about Mototok at www.mototok.com.



Mototok International GmbH

Hohenzollernstr. 47 · 47799 Krefeld · Germany
Phone: +49 2151 65083 82 · Fax: +49 2151 61660 99

info@mototok.com · www.mototok.com · fb.com/MototokTugs



AIRBUS

*airservice*basel



BRITISH AIRWAYS

BOMBARDIER
the evolution of mobility



Gulfstream

