

**Model: 02-7935C0000**  
**Proof Load Fixture**  
**50 Ton**



02/2022 – Rev. 02

REVISION	DATE	TEXT AFFECTED
01	06/2013	Original Release
02	02/2022	Major revision

TABLE OF CONTENTS

	<u>PAGE</u>
<b>1.0 PRODUCT INFORMATION .....</b>	<b>1</b>
1.1 DESCRIPTION.....	1
1.2 MODEL & SERIAL NUMBER.....	1
1.3 MANUFACTURER.....	1
1.4 SPECIFICATIONS .....	1
<b>2.0 SAFETY INFORMATION.....</b>	<b>2</b>
2.1 USAGE AND SAFETY INFORMATION .....	2
<b>3.0 OPERATION.....</b>	<b>2</b>
<b>4.0 MAINTENANCE.....</b>	<b>4</b>
<b>5.0 PROVISION OF SPARES.....</b>	<b>5</b>
5.1 SOURCE OF SPARE PARTS.....	5
5.2 RECOMMENDED SPARE PARTS LISTS .....	5
<b>6.0 IN SERVICE SUPPORT.....</b>	<b>5</b>
<b>7.0 GUARANTEES/LIMITATION OF LIABILITY .....</b>	<b>5</b>
<b>8.0 APPENDICIES.....</b>	<b>5</b>

This product can not be modified without the written approval of Tronair, Inc. Any modifications done without written approval voids all warranties and releases Tronair, Inc., its suppliers, distributors, employees, or financial institutions from any liability from consequences that may occur. Only Tronair OEM replacement parts shall be used.

## 1.0 PRODUCT INFORMATION

### 1.1 DESCRIPTION

This Tronair Proof Load Fixture, Model 02-7935C0000, is designed to test the hydraulic load and pressure relief valve of tripod jacks.

Proof load fixture is used on:

02A7889C0100	02A7895C0100	02A7897C0100	02A7922C0100
02A7890C0100	02A7896C0100	02A7904C0100	02A7945C0100

### 1.2 MODEL & SERIAL NUMBER

Reference nameplate on unit

### 1.3 MANUFACTURER

**TRONAIR, Inc.**  
1 Air Cargo Pkwy East  
Swanton, Ohio 43558 USA

Telephone: (419) 866-6301 or 800-426-6301  
Fax: (419) 867-0634  
E-mail: sales@tronair.com  
Website: www.tronair.com

### 1.4 SPECIFICATIONS

Maximum Load Capacity..... 100,000 lbs (45,359 kg)  
Weight..... 80 lbs (36 kg)

Digital Read Out Power Input:

AC plug ..... 110/240 VAC 50/60 Hz  
Four (4) AA batteries (alkaline or rechargeable NiMh, NiCad) not included

**NOTE: Load cell cable is located between tension struts. Mount load cell to fixture as show in Figure. Use four ¼ - 20 x 4 ½ long socket head cap screws. Torque screws to 100 in/lbs (11.30 Nm)**

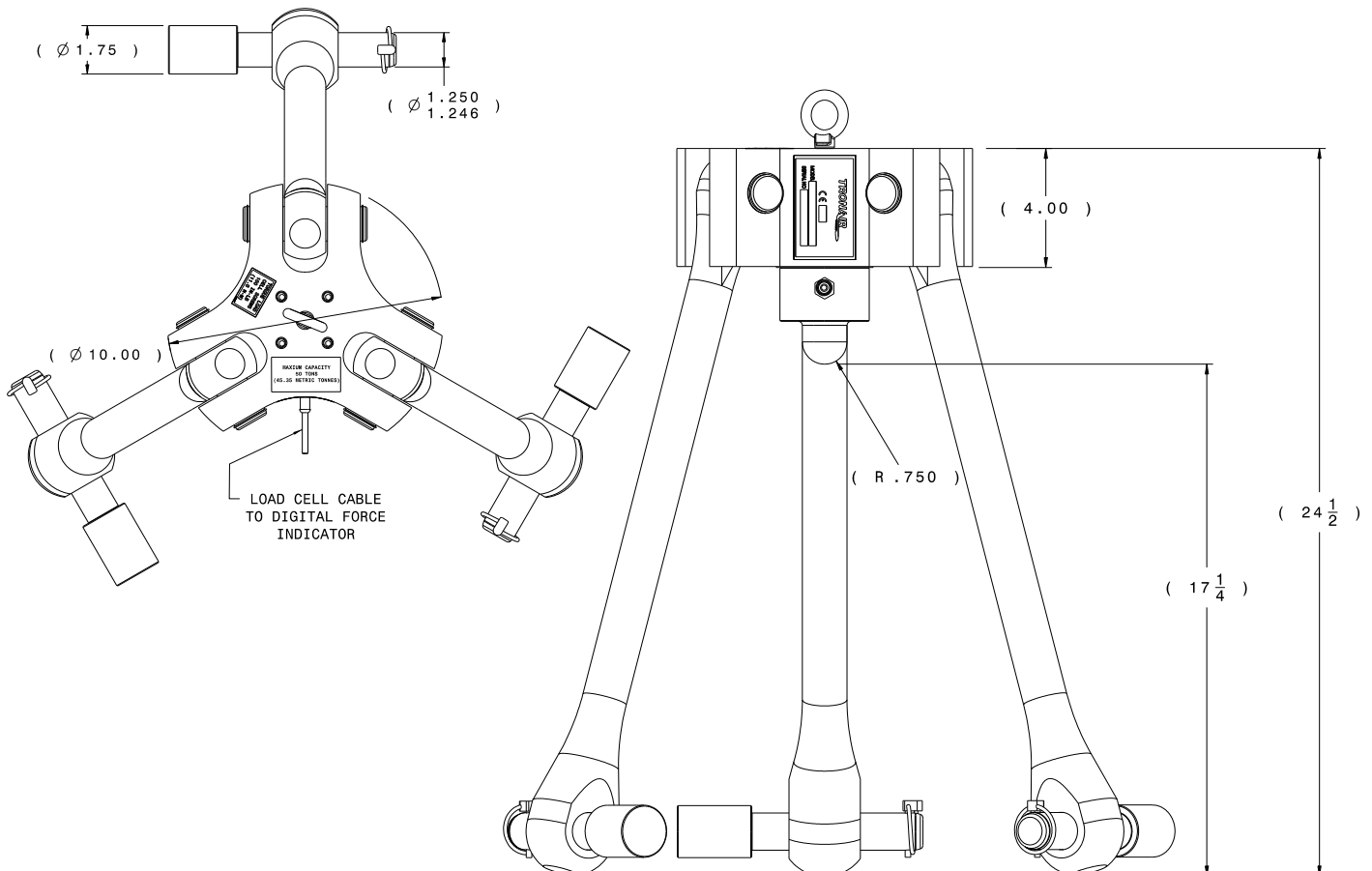

**2.0 SAFETY INFORMATION****2.1 USAGE AND SAFETY INFORMATION**

To insure safe operations please read the following statements and understand their meaning. Also refer to your equipment manufacturer's manual for other important safety information. This manual contains safety precautions which are explained below. Please read carefully.

**WARNING!**

Warning is used to indicate the presence of a hazard that can cause **severe personal injury, death, and/or substantial property damage** if the Warning Notice is ignored.

**CAUTION!**

Caution is used to indicate the presence of a hazard, which will or can cause **minor personal injury or property damage** if the Caution Notice is ignored.

**3.0 OPERATION****CAUTION!**

**Operator injury and/or component damage can result.**

**Be sure to read all instructions before testing.**

1. Raise mechanical extension 2-4 inches
2. Raise ram approximately 6-8 inches
3. Lower safety lock nut to avoid contact with tension strut
4. Lower proof load fixture and install 1 ¼ pins into holes (as shown on following page)
5. Lock all lynch pins into place
6. Continue to actuate ram until jack pad contacts load cell
7. Zero digital load indicator
8. Actuate ram with hand pump until pressure relief valve relieves

**NOTE: Hand pump is relieved when continual pumping will not produce a greater load reading**

9. Digital load indicator reading should be 105%-110% of load capacity (see Jack Proof Load Test Data sheet in 4.0 Maintenance)
10. Release hydraulic pressure
11. Lower ram, mechanical extension and remove load fixture from jack

### 3.0 OPERATION (continued)

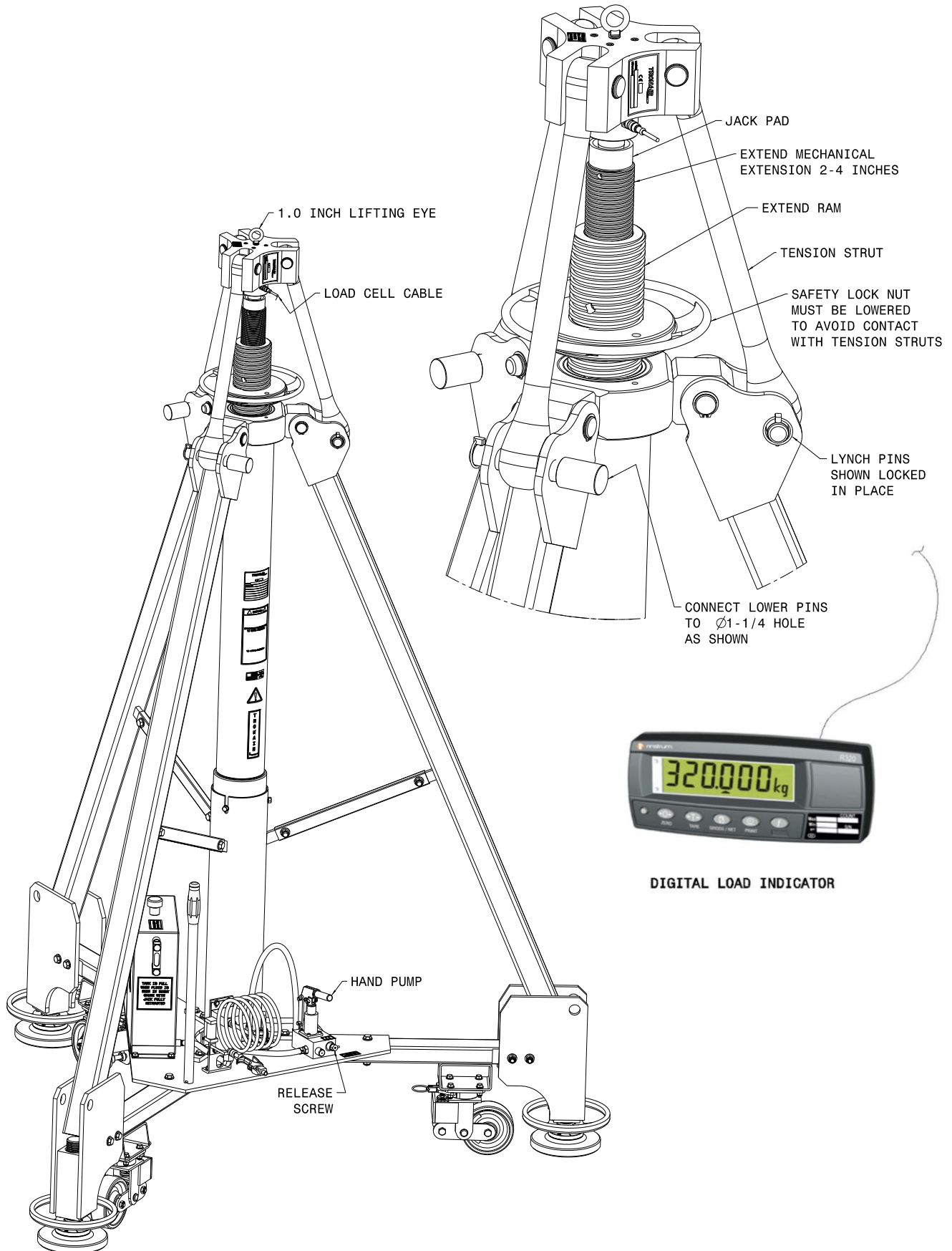



## 5.0 PROVISION OF SPARES

### 5.1 SOURCE OF SPARE PARTS

Spare parts may be obtained from the manufacturer:

**TRONAIR**, Inc.

1 Air Cargo Pkwy East

Swanton, Ohio 43558 USA

Telephone: (419) 866-6301 or 800-426-6301

Fax: (419) 867-0634

E-mail: sales@tronair.com

Website: www.tronair.com

### 5.2 RECOMMENDED SPARE PARTS LISTS

Reference the following page(s) for Replacement Parts and Kits available.

## 6.0 IN SERVICE SUPPORT

Contact Tronair, Inc. for technical services and information. See Section 1.3 – Manufacturer.

## 7.0 GUARANTEES/LIMITATION OF LIABILITY

Tronair products are warranted to be free of manufacturing or material defects for a period of one year after shipment to the original customer. This is solely limited to the repair or replacement of defective components. This warranty does not cover the following items:

- a) Parts required for normal maintenance
- b) Parts covered by a component manufacturers warranty
- c) Replacement parts have a 90-day warranty from date of shipment

If you have a problem that may require service, contact Tronair immediately. Do not attempt to repair or disassemble a product without first contacting Tronair, any action may affect warranty coverage. When you contact Tronair be prepared to provide the following information:

- a) Product Model Number
- b) Product Serial Number
- c) Description of the problem

If warranty coverage is approved, either replacement parts will be sent or the product will have to be returned to Tronair for repairs. If the product is to be returned, a Return Material Authorization (RMA) number will be issued for reference purposes on any shipping documents. Failure to obtain a RMA in advance of returning an item will result in a service fee. A decision on the extent of warranty coverage on returned products is reserved pending inspection at Tronair. Any shipments to Tronair must be shipped freight prepaid. Freight costs on shipments to customers will be paid by Tronair on any warranty claims only. Any unauthorized modification of the Tronair products or use of the Tronair products in violation of cautions and warnings in any manual (including updates) or safety bulletins published or delivered by Tronair will immediately void any warranty, express or implied.

The obligations of Tronair expressly stated herein are in lieu of all other warranties or conditions expressed or implied. **Any unauthorized modification of the Tronair products or use of the Tronair products in violations of cautions and warnings in any manual (including updates) or safety bulletins published or delivered by Tronair will immediately void any warranty, express or implied and Tronair disclaims any and all liability for injury (WITHOUT LIMITATION and including DEATH), loss or damage arising from or relating to such misuse.**

## 8.0 APPENDICIES

APPENDIX I Declaration of Conformity

APPENDIX II R320 Digital Indicator Operator Manual



## Parts List

When ordering replacement parts/kits, please specify model, serial number and color of your unit.

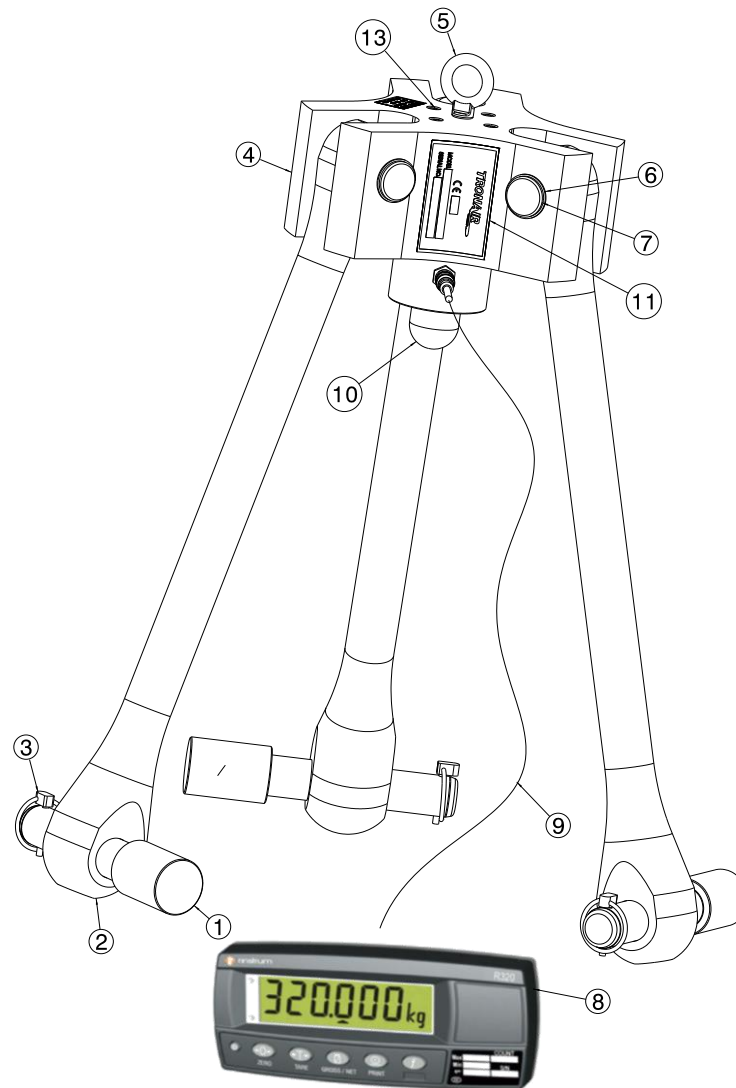

Item	Part Number	Description	Qty
1	R-2795	Pin, Lower Leg	3
2	R-2790-01	Strut, Tension	3
3	G-1320-01	Pin, Lynch	3
4	R-2792-01	Base, Load Cell	1
5	G-1331-03	Eyebolt, Lifting, 3/8 - 16 thread	1
6	G-1397-125	Ring, Retaining	6
7	R-2791	Pin, Upper Leg	3
8	EC-2667	Indicator, Digital Force (w/ Pelican case)	1
9	EC-2666-01	Cable, Lad Cell, 4 meters long	1
10	EC-2665	Cell, Load, 50 tons	1
11	V-1779	Label, Serial Number	1
13	G-1151-105244	Screw, SOC HD CAP, 1/4 - 20 x 4 1/2	4
N/S	V-1001	Label, Made In USA	1
N/S	V-2469	Label, Maximum Capacity, 50 ton	1
N/S	<b>V-2503</b>	Label, Tolerance Load Cell Screws	1





## **APPENDIX I**

### **Declaration of Conformity**





## DECLARATION of CONFORMITY

The design, development and manufacture is in accordance with European Community guidelines

Proof Load Fixture  
02-7935C0000

Relevant provisions complied with by the machinery:  
2006/42/EC

Relevant standards complied with by the machinery:  
EN ISO 12100-1

Identification of person empowered to sign on behalf of the Manufacturer:

A handwritten signature in black ink that reads "Patrick Finch". The signature is written in a cursive style and is positioned above a horizontal line.

Quality Assurance Representative





## APPENDIX II

### R320 Digital indicator Operator Manual





SMART WEIGHING SOLUTIONS



**R300 Series**  
(R310, R320 and R321)  
**Digital Indicator**  
**Operator Manual**

For use with Software Versions 1.1 and above

R300-601-150

### **Copyright**

All Rights Reserved. No part of this document may be copied, reproduced, republished, uploaded, posted, transmitted, distributed, stored in or introduced into a retrieval system in any form, or by any means (electronic, mechanical, photocopying, recording or otherwise) whatsoever without prior written permission of Rinstrum Pty Ltd.

### **Disclaimer**

Rinstrum Pty Ltd reserves the right to make changes to the products contained in this manual in order to improve design, performance or reliability.

The information in this manual is believed to be accurate in all respects at the time of publication, but is subject to change without notice. Rinstrum Pty Ltd assumes no responsibility for any errors or omissions and disclaims responsibility for any consequences resulting from the use of the information provided herein.

---

*"Everything should be made as simple as possible, but not simpler."*

*- Albert Einstein -*

---

## Table of Contents

<b>1. INTRODUCTION</b> .....	<b>4</b>
1.1. Approvals.....	4
1.2. Features.....	4
1.3. Manuals.....	4
<b>2. SAFETY</b> .....	<b>6</b>
2.1. Operating Environment.....	6
2.2. Electrical Safety.....	6
2.3. Cleaning.....	6
<b>3. BASIC OPERATION</b> .....	<b>7</b>
3.1. User Interface Display and Controls .....	7
3.2. Operation Keys .....	8
3.3. Stability Considerations .....	10
3.4. Annunciators.....	11
<b>4. BASIC WEIGHING</b> .....	<b>12</b>
4.1. Normal Weighing .....	12
4.2. Using Tare .....	12
<b>5. SPECIAL FUNCTIONS (R320 ONLY)</b> .....	<b>13</b>
5.1. Testing the Display .....	13
5.2. Counting .....	13
5.3. Units Switching (kg / lb) .....	14
5.4. Hold .....	14
5.5. Peak Hold.....	14
5.6. Live Weighing .....	15
5.7. Showing Totals .....	16
<b>6. ERROR MESSAGES</b> .....	<b>17</b>
6.1. Weighing Errors.....	17
6.2. Setup and Calibration Errors.....	18
6.3. Diagnostic Errors .....	19

## 1. Introduction

The Rinstrum **R300 Series** are precision digital indicators using the latest Sigma-Delta A/D technology to ensure fast and accurate weight readings.

This manual contains information on the operation of the **R310**, **R320** and **R321**.

**Note:** The **R321** is the **R320** enclosed in a stainless steel housing. In this manual any reference to the **R320** includes the **R321**.

Unless otherwise indicated, all information will apply to the **R310**, **R320** and **R321**. For the purposes of readability, where all instruments are being described, they will be referred to as the **R300 Series**.

### 1.1. Approvals

- NSC approval (4000 divisions at 0.8 $\mu$ V/division).
- NMI approval (4000 divisions at 0.8 $\mu$ V/division).
- C-tick approved and CE approved.

### 1.2. Features

- **R310** has Zero and Tare functionality.
- **R320** has Zero and Tare functionality as well as battery backed clock/calendar, special function key (for counting, live weight averaging, peak-hold, etc.).

### 1.3. Manuals

For more information on the **R300 Series** refer to the **R300 Series Reference Manual**, **R300 Series Quick Start Manual** and **R300 Series Communications Manual** (available free of charge from [www.rinstrum.com](http://www.rinstrum.com)).

**R310**



**R320**



**R321**



## 2. Safety

### 2.1. Operating Environment

- Operating Temperature: –10 to 50°C
- Humidity: <90% non-condensing
- Operating Voltage: Shown on Rear Label

### 2.2. Electrical Safety

- For your protection all mains electrical hardware must be rated to the environmental conditions of use.
- Pluggable equipment must be installed near an easily accessible power socket outlet.
- To avoid the possibility of electric shock or damage to the instrument, always switch off or isolate the instrument from the power supply before maintenance is carried out.

### 2.3. Cleaning

- To maintain the instrument, never use harsh abrasive cleaners or solvents. Wipe the instrument with a soft cloth **slightly** dampened with warm soapy water.

### 3. Basic Operation

#### 3.1. User Interface Display and Controls

##### R310



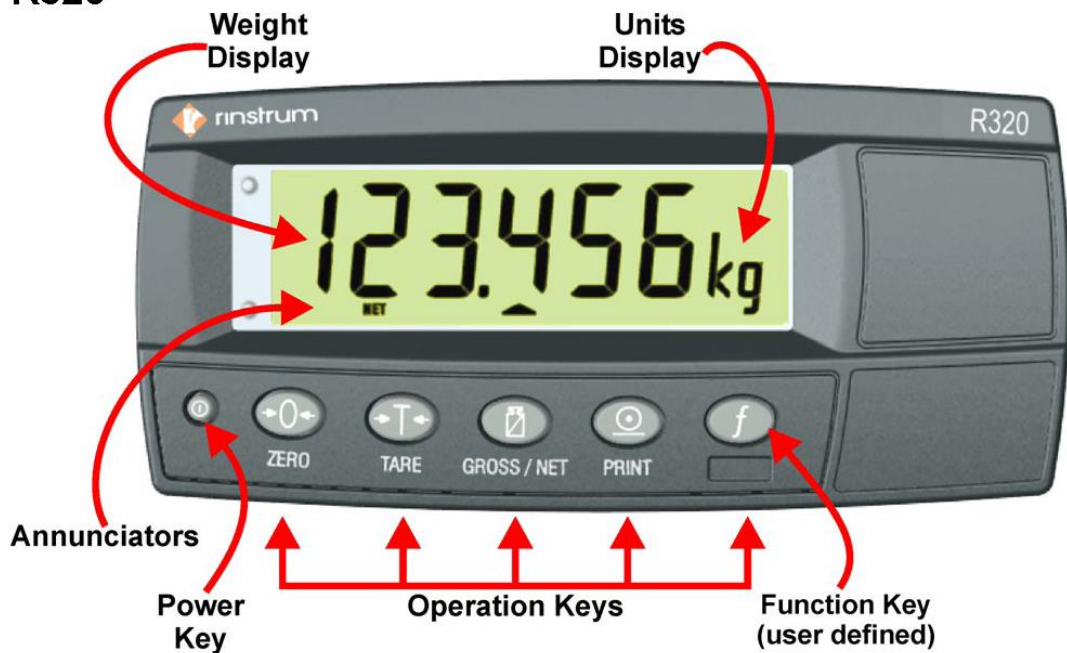

##### R320



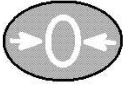

### 3.2. Operation Keys

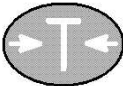
Key	Description
	<p><b>POWER:</b> The &lt;POWER&gt; key is used to turn the instrument on and off.</p> <ul style="list-style-type: none"> <li>• <b>To initially turn the instrument ON:</b> Press and hold the &lt;POWER&gt; key until the display starts up.</li> <li>• <b>To turn the instrument OFF:</b> Press and hold the &lt;POWER&gt; key for three seconds. The instrument will display <b>OFF</b> followed by the three-second countdown.</li> </ul> <p><b>Note:</b> If the &lt;POWER&gt; key has been locked, the instrument cannot be turned off from the front keypad.</p> <ul style="list-style-type: none"> <li>• <b>Battery Operation:</b> When using batteries the backlight will automatically turn off to conserve power after a short period of inactivity. A short press of the &lt;POWER&gt; key will turn the backlight on again.</li> <li>• <b>Automatic Operation:</b> The &lt;POWER&gt; key has a memory function associated with it. This means that the state of the power setting is remembered even if external power is interrupted. It is therefore possible to turn the instrument on in the safe knowledge that it will operate whenever external power is available and will not need to be manually turned on again if the power is interrupted.</li> </ul>
 <p><b>ZERO</b></p>	<p><b>ZERO:</b> The &lt;ZERO&gt; key is used to perform a Zero adjustment on the scale display when an empty scale has drifted away from a true zero reading.</p> <ul style="list-style-type: none"> <li>• On the <b>R320</b>, the Zero adjustment is stored when power is removed and is re-used when next powered up.</li> <li>• <b>Long Press:</b> When the indicator is set to Industrial mode a long press of the &lt;ZERO&gt; key will remove any stored zero adjustment.</li> </ul>











Key	Description
 <b>TARE</b>	<p><b>TARE:</b> The &lt;TARE&gt; key is used to temporarily set the scale to zero (such as cancelling the weight of a carton before performing a filling operation). The display will show the Net weight and the <b>Net</b> annunciator will be lit.</p> <ul style="list-style-type: none"> <li>• The &lt;TARE&gt; key can operate in all modes (ie. Industrial, OMIL and NTEP).</li> <li>• The weight tared is deducted from the allowable range of the scale, reducing the maximum weight that can be displayed.</li> <li>• On the <b>R320</b>, the Tare adjustment is stored when power is removed and is re-used when next powered up.</li> </ul>
 <b>GROSS/NET</b>	<p><b>GROSS/NET:</b> The &lt;GROSS/NET&gt; key toggles the weight display between the Gross weight and the Net weight (provided that a Tare has previously been acquired using the &lt;TARE&gt; key).</p>
 <b>PRINT</b>  <b>R320 Only</b>	<p><b>PRINT:</b> The &lt;PRINT&gt; key on the <b>R320</b> will trigger an output of the current weight reading if a printer or computer has been attached to the instrument and the manual print function has been selected.</p> <ul style="list-style-type: none"> <li>• The <b>PRINT</b> prompt is displayed while waiting for the printer to accept data.</li> <li>• If the printer is offline the <b>PRINT</b> prompt will remain for a maximum of 10 seconds before the operation is cancelled.</li> <li>• Each weight printed is automatically added to an internal total weight.</li> <li>• <b>Long Press:</b> A long press of the &lt;PRINT&gt; key will print the total. The total weight is then cleared automatically.</li> </ul>

Key	Description
 <b>TEST</b>  <b>R310 Only</b>	<p><b>TEST:</b> The &lt;TEST&gt; key on the R310 is used to initiate a display test.</p> <ul style="list-style-type: none"> <li>Once pressed the display is shown with all segments clear, then all segments lit and then all segments clear again before returning to normal operation.</li> <li>On the R320 the equivalent function is available only when TEST has been assigned to the user defined &lt;FUNCTION&gt; key. Refer to Testing the Display page 13.</li> </ul>
   <b>R320 Only</b>	<p><b>FUNCTION:</b> The &lt;FUNCTION&gt; key on the R320 is programmable to suit customer requirements. A label identifying the special function will be attached. Refer to Special Functions page 13 for details of the available functions.</p> <ul style="list-style-type: none"> <li><b>Long Press:</b> A long press of the &lt;FUNCTION&gt; key may be used for certain functions depending on the primary function of the key.</li> </ul>

### 3.3. Stability Considerations

Once a <ZERO>, <TARE> or <PRINT> key is pressed the unit waits for a stable valid reading before performing the associated operation. If the weight readings remain unstable or invalid due to some diagnostic error for longer than 10 seconds, the operation is cancelled and the **STABLE ERROR** message is displayed.

### 3.4. Annunciators

Symbol	Name	Description
	ZERO	Visible when the gross reading is within $\pm \frac{1}{4}$ of a division of true zero.
	NET	Visible when the displayed reading represents Net weight.
	MOTION	Visible when the displayed reading is not stable.
	OVER	Visible when the setpoint weight is over the setpoint target.
	UNDER	Visible when the setpoint weight is under the setpoint target.
	ZERO BAND	Visible when the displayed weight is within the zero 'dead' band setting. (The zero band symbol shows near the top right corner of the display.)
	HOLD	Visible when the displayed reading is held.
	LOW BATTERY	Visible when battery voltage is too low and batteries need replacing or recharging. (The low battery symbol shows in the top right corner of the display.)

## 4. Basic Weighing

### 4.1. Normal Weighing

- Ensure instrument is On and **Zero** annunciator is lit.
- Place your item on the weigh platform.
- Read the weight display.

### 4.2. Using Tare

- The indicator displays zero with **Zero** annunciator lit.
- Place the container on the weigh platform.
- Press the **<TARE>** key.

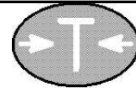

**TARE**

- The indicator will show the displayed zero weight and the **Net** annunciator will be lit.
- Fill the container to the required weight.
- Press the **<GROSS/NET>** key to toggle between the Net weight and the Gross (total) weight.



**GROSS/NET**

## 5. Special Functions (R320 Only)

### 5.1. Testing the Display

- Press the <TEST> key to clear the display then show all segments of the display then clear the display again before returning to normal operation.



**TEST**

**Note:** This feature is also available on the **R310**. For more information refer to **TEST** key page 10.

### 5.2. Counting

- Place the container on the weigh platform and press <TARE> if required.

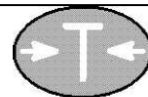

**TARE**

- Place the sample pieces to be counted on the weigh platform.

- Press and hold the <COUNT> key for two seconds. The default number of pieces in the sample will be displayed.

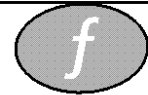

**COUNT**

- Use the <GROSS/NET> and <PRINT> keys to alter the number of pieces.



**GROSS/NET** and **PRINT**





- Press <COUNT>. The current sample will be stored against the entered pieces. The letter **p** (for pieces) displays when in counts display.







**COUNT**

- Press the <COUNT> key to toggle between the weight display and the counts display.
- If printing is enabled the sample quantity and weight will be printed.







### 5.3. Units Switching (kg / lb)

<ul style="list-style-type: none"><li>• Press the &lt;UNITS&gt; key to switch the display between kilograms and pounds.</li></ul>	 
<ul style="list-style-type: none"><li>• Printing and serial communications will use the units displayed (either lb or kg).</li></ul>	





### 5.4. Hold

<ul style="list-style-type: none"><li>• Press the &lt;HOLD&gt; key to hold the displayed weight at its current weight.</li></ul>	 
<ul style="list-style-type: none"><li>• The <b>Hold</b> annunciator will be lit.</li></ul>	
<ul style="list-style-type: none"><li>• Press the &lt;HOLD&gt; key again to release the weight reading and return the display to normal weighing.</li></ul>	 
<ul style="list-style-type: none"><li>• All printouts that print the displayed weight will use the held weight reading if it is currently being displayed.</li></ul>	

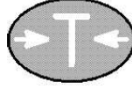
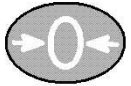

### 5.5. Peak Hold

<ul style="list-style-type: none"><li>• Press the &lt;PEAK&gt; key to show the largest absolute weight, either positive or negative (eg. -30 is larger than 25). The <b>R320</b> compares the current weight reading with the stored peak and updates the peak reading whenever a larger weight is detected.</li></ul>	 
<ul style="list-style-type: none"><li>• The <b>Hold</b> annunciator will be lit.</li></ul>	
<ul style="list-style-type: none"><li>• Press the &lt;PEAK&gt; key to toggle between the current weight and the peak weight.</li><li>• When displaying the peak weight the <b>Hold</b> annunciator will be lit.</li></ul>	 
<ul style="list-style-type: none"><li>• When displaying the peak weight, press and hold the &lt;PEAK&gt; key for two seconds to clear the peak value and reset back to 0 (zero).</li></ul>	 
<ul style="list-style-type: none"><li>• All printouts that print the displayed weight will use the held weight reading if it is currently being displayed</li></ul>	

## 5.6. Live Weighing

<ul style="list-style-type: none"><li>• Press and hold the <b>&lt;LIVE WT&gt;</b> key to switch between normal weighing and live weight mode. The display will briefly show <b>NORMAL</b> or <b>LIVE.WT</b>.</li></ul>	 
<ul style="list-style-type: none"><li>• <b>Note:</b> During normal weighing, this key operates exactly like a manual <b>&lt;HOLD&gt;</b> key.</li></ul>	
<ul style="list-style-type: none"><li>• When in Live-Weight mode and while the Net weight is within the zero 'dead' band, the instrument shows the current weight.</li></ul>	
<ul style="list-style-type: none"><li>• Press the <b>&lt;TARE&gt;</b> or <b>&lt;ZERO&gt;</b> key to clear any residual weight and return the scale to the zero state.</li></ul>	  <b>TARE or ZERO</b>
<ul style="list-style-type: none"><li>• Move the animal on to the weigh platform.</li></ul>	
<ul style="list-style-type: none"><li>• Once the weight moves outside the zero 'dead' band the instrument begins to calculate a long-term average that compensates for any movement in the mass. The instrument flashes the <b>Hold</b> annunciator and shows the current average value.</li><li>• The <b>Hold</b> annunciator is steady when the final sample weight is shown on the display.</li></ul>	
<ul style="list-style-type: none"><li>• Press the <b>&lt;LIVE.WT&gt;</b> key to force the sample to be recalculated.</li></ul>	 
<ul style="list-style-type: none"><li>• Once the animal is removed, the <b>R320</b> automatically clears the previous reading ready for the next animal.</li></ul>	

### 5.7. Showing Totals

<ul style="list-style-type: none"><li>• The <b>&lt;PRINT&gt;</b> key is used not only to print the current weight but also to add that weight to the current total.</li></ul>	 <b>PRINT</b>
<ul style="list-style-type: none"><li>• When the <b>&lt;TOTAL&gt;</b> key is pressed, the indicator displays <b>COUNT</b> followed by the number of items in the total.</li></ul>	 <b>TOTAL</b>
<ul style="list-style-type: none"><li>• After this the indicator displays <b>TOTAL</b> followed by the current total weight.</li></ul>	
<ul style="list-style-type: none"><li>• If the total weight is too large to display in six digits, the weight is shown in two sections labelled with the upper six digits displayed before the lower six digits.</li></ul>	
<ul style="list-style-type: none"><li>• Press and hold the <b>&lt;PRINT&gt;</b> key to cause the total accumulated weight to be printed and then cleared.</li></ul>	 <b>PRINT</b>



## 6. Error Messages

### 6.1. Weighing Errors

Error	Description	Resolution
(U - - - - -)	The weight is below the minimum allowable weight reading.	Increase the weight or decrease the minimum allowable weight reading.
(O - - - - -)	The weight is above the maximum allowable weight reading. Warning - overloading may damage mechanical scale elements.	Check the condition of load cell connections. Check for damaged load cell.
(ZERO) (ERROR)	The weight reading is beyond the limit set for Zero operation. The operation of the <ZERO> key is limited in the setup during installation. The indicator cannot be Zeroed at this weight.	Increase the Zero Range (OPTION: Z.RANGE) or use the <TARE> key instead.
(STABLE) (ERROR)	Scale motion has prevented a <ZERO>, <TARE> or <PRINT> operation from occurring on command.	Try the operation again once the scale is stable.

## 6.2. Setup and Calibration Errors

Error	Description	Resolution
(ENTRY) (DENIED)	The instrument may be in Safe Setup and an item that needs Full Setup has been selected for editing.	Access Full Setup to edit the item.
	When accessing setup, more than three attempts have been made with the incorrect passcode.	Turn the instrument off. When the instrument is turned back on, enter the correct passcode to access setup.
(LIN.PT) (LO)	An attempt has been made to place a linearisation point below zero.	Incorrect linearisation point entered (must be between zero and full scale).
(PT.TOO) (CLOSE)	An attempt has been made to place a calibration point too close to an existing calibration point.	Re-enter the calibration point. Points must be spaced by at least 2% of full scale from each other.
(RES) (LO)	The scale build is configured for less than 100 graduations.	Check the resolution (count-by) and capacity settings.
(RES) (HIGH)	The scale build is configured for more than 30,000 graduations.	Check the resolution (count-by) and capacity settings.
(SPAN) (LO)	The load cell signal range (span) is too small for these settings.	Incorrect span weight entered (must be between zero and full scale). Scale wiring incorrect. Wrong load cell capacity (too large). Wrong or no calibration weight added to scale.
(SPAN) (HI)	The load cell signal range (span) is too large for these settings.	Incorrect span weight entered (must be between zero and full scale). Scale wiring incorrect. Load cell capacity too small for application.
(ZERO) (LO)	An attempt has been made to calibrate zero below -2mV/V.	Scale wiring incorrect.
(ZERO) (HI)	An attempt has been made to calibrate zero above +2mV/V.	Remove all weight from scale. Scale wiring incorrect.

### 6.3. Diagnostic Errors

- Check: Service personnel can check this item on site.
- Return for Service: The instrument must be returned to the manufacturer for factory service.

Error	Description	Resolution
(E0001)	The power supply voltage is too low.	Check supply
(E0002)	The power supply voltage is too high.	Check scale / cables
(E0010)	The temperature is outside of allowable limits.	Check location
(E0020)	Scale build is incorrect. The number of graduations has been set too low or too high.	Fix up scale build
(E0100)	The digital setup information has been lost.	Re-enter setup
(E0200)	The calibration information has been lost.	Re-calibrate
(E0300)	All setup information has been lost	Enter setup and calibrate
(E0400)	The factory information has been lost.	Return for Service
(E0800)	The EEPROM memory storage chip has failed	Return for Service
(E2000)	ADC Out of Range Error. This may be caused from a broken load cell cable.	Check BUILD:CABLE setting. Check load cell cable, wiring, etc.
(E4000)	The battery backed RAM data has lost data.	Re-enter setup
(E8000)	The FLASH program memory is incorrect	Return for Service

The **E** type error messages are additive. For example if instrument is running off batteries and the temperature drops, the battery voltage may be too low. The resulting error messages will be **E0011** (0001 + 0010). The numbers add in hexadecimal as follows:

**1 - 2 - 3 - 4 - 5 - 6 - 7 - 8 - 9 - A - B - C - D - E - F**  
 (For example, 2 + 4 = 6, or 4 + 8 = C)

**SMART WEIGHING SOLUTIONS**

